



Charging generator AG 30



Operating instructions

Charge Line

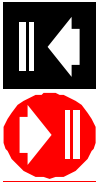

Types

AG 30 positive	115 V	09.7701.200, 09.7801.000
AG 30 positive	230 V	09.7700.200, 09.7800.000
AG 30 negative	115 V	09.7703.200, 09.7803.000
AG 30 negative	230 V	09.7702.200, 09.7802.000

Keep in a safe place for future reference!

Table of contents

1	Notes on operating instructions.....	4
1.1	Pictorial markings used.....	4
2	Safety.....	5
2.1	Intended use.....	5
2.2	Danger sources.....	6
2.3	Installer qualifications.....	6
2.4	Operator qualifications.....	6
3	Description of unit.....	7
4	Installation.....	9
4.1	Important installation instructions.....	9
4.2	Setting up, connecting.....	10
4.3	Connection socket K1.....	11
5	Application.....	12
5.1	Putting into operation.....	12
5.2	Instructions for setting the high voltage.....	13
6	Remedy of defects.....	14
6.1	Troubleshooting.....	14
7	Maintenance and repairs.....	15
7.1	Replacing fuse.....	15
7.2	Accessories.....	16
8	Technical data.....	17
8.1	Connectable charging units.....	17
8.2	Characteristics and specification.....	17
8.3	Supply voltage.....	17
8.4	Ambient conditions.....	18
8.5	Housing.....	18
9	Disposal.....	19

1 Notes on operating instructions

In these operating instructions, the AG 30 is also referred to as "unit".

1.1 Pictorial markings used



In these operating instructions



WARNING!
High voltage!
Danger of fatal accidents!
Do not open unit!



WARNING!
Only plug in/unplug coaxial connector when the unit is switched off!



ATTENTION!
Important instructions!



On the unit



WARNING!
High voltage!
Danger of fatal accidents!
Do not open unit!

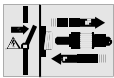

WARNING!
Only plug in/unplug coaxial connector when the unit is switched off!

2

Safety

The unit is operationally safe, provided that it is operated in accordance with its intended use.

In case of misuse, dangers may result:

- for life and limb of the operator,
- for the unit and other assets.

Also note Chapter 4.1 (refer to page 9 "Important installation notes").

2.1

Intended use



ATTENTION!

Do not install or use the unit in areas subject to explosion hazards!

The charging generator AG 30 is intended exclusively for the high-voltage supply of HAUG charging units.

It generates an adjustable direct high voltage of 0...40 kV, with positive or negative polarity, depending on the unit type.

The direct high voltage is intended for charging material webs in industrial production processes.

For reasons of safety, unauthorized conversions and modifications of the unit are not permitted.

The installation and operating conditions indicated in these Operating Instructions must be adhered to.

2.2 Danger sources



WARNING!

*The charging units connected to the charging generator conduct high voltage during operation!
Any contact may lead to injury and consequential accidents.
The operator must provide protective equipment against direct contact when installing the charging units. Make sure that you read and observe the operating instructions of the connected charging units.*



WARNING!

Only plug in/unplug coaxial connector when the unit is switched off!

Defective high-voltage terminals and cables may lead to danger of electric shocks.
Shut down the unit immediately in case of visible damage and suspected electrical defects.

2.3 Installer qualifications

The unit may be installed by trained electricians only. The above mentioned person must have read the operating instructions and must follow the instructions, notes and safety advice.

2.4 Operator qualifications

The unit may be maintained and put into operation by trained electricians only or by authorized persons informed about the potential dangers. The above mentioned persons must have read the operating instructions and must follow the instructions, notes and safety advice.

3 Description of unit

Figure 1

1. Connection socket K1 (Pulse-/Signalling connection)
2. Mains supply
3. Fuse (for replacement refer to page 15, Section 7.1)
4. Ground connection (terminal)
5. High-voltage terminals

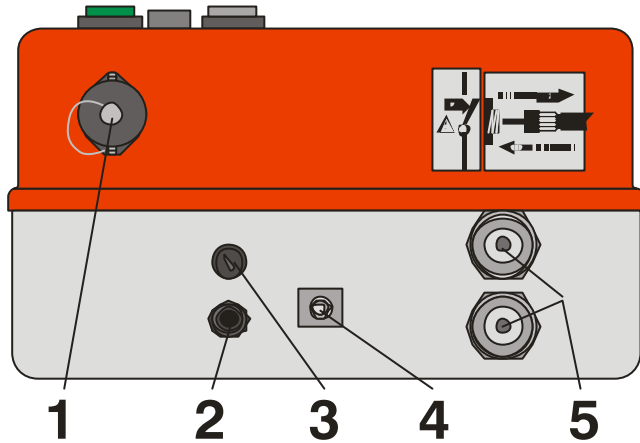
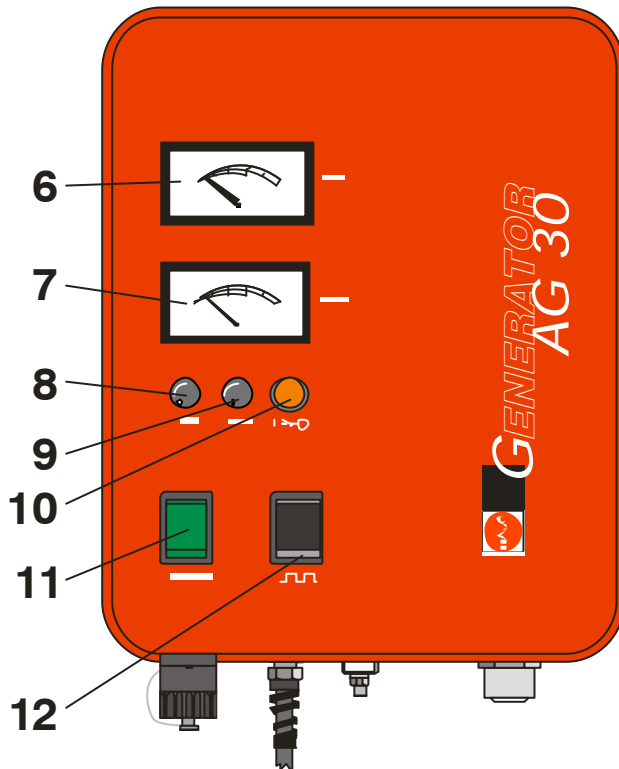

Figure 2

6. Voltage display kVDC
7. Current display mA
8. High voltage potentiometer
9. Current threshold potentiometer
10. Reset pushbutton
11. Mains switch: Switch lights up green when the unit is switched on.
12. Toggle switch pulsed/permanent operation



4 Installation

The unit may be installed by trained electricians only. The above mentioned person must have read the operating instructions and must follow the instructions, notes and safety advice.

4.1 Important installation instructions



WARNING!
High voltage!
Danger of fatal accidents!
Do not open unit!



WARNING!
Only plug in/unplug coaxial connector
when the unit is switched off!

The operation of the unit is not affected by the position in which it is installed. However, we recommend installing the unit so that the high-voltage terminals points downwards (to protect it from humidity, oil and dirt).

Do not place the unit on a surface generating or radiating heat. Avoid installation positions exposed to direct sunlight.

4.2 Setting up, connecting

**WARNING!**

The charging units connected to the charging generator conduct high voltage during operation!

Any contact may lead to injury and consequential accidents.

The operator must provide protective equipment against direct contact when installing the charging units. Make sure that you read and observe the operating instructions of the connected charging units.

**WARNING!**

Only plug in/unplug coaxial connector when the unit is switched off!

1. Before connecting always check that the unit is suitable for the local mains voltage (the voltage is indicated on the name plate). Incorrect mains voltage may result in damage to the unit.
2. Attach unit at the desired location using the enclosed retaining plates.
3. Ensure that the unit is switched off (for mains switch, refer to page 8, Fig. 2, item 11).
4. Connect charging units to high-voltage terminals.
5. Connect the PE conductor (green-yellow) with the protective earth of the mains. Connecting the PE conductor via parts of a machine body is insufficient.
6. If required, connect the signaling line K1 to the connection socket K1 (refer to page 7, Fig. 1, item 1).
7. Connect the unit to the mains.
8. Put unit into operation.

4.3

Connection socket K1

**ATTENTION!**

No destructive electrical loads may be applied to the signalling contacts (to protect the electronic system of the unit). Before plugging in the signal line K1, please self-discharge by touching grounded machine parts.

1. Connect the connector in accordance with the following terminal assignment diagram.
2. Plug in the connector.
3. The charging generator triggers a signal when the set current threshold is exceeded.
4. The charging generator can be pulsed via an external contact.

Note:

If a pulse frequency of more than 0.5 Hz is chosen, the measuring instrument (kV) will be unable to follow the on/off cycles. The measuring instrument's (kV) inertia does not affect its function, however. The unit will perform the pulses properly up to 1 Hz max.

Figure 3

Pin 1: Joint connection relay

Pin 2: Normally closed contact: Open when current threshold has been exceeded.

Pin 3: Switching contact: Closed when current threshold has been exceeded.

Pin 4: Not assigned

Pin 5 and 6: Connection of a floating normally open contact (Pulse signal)

PE: Shield ground

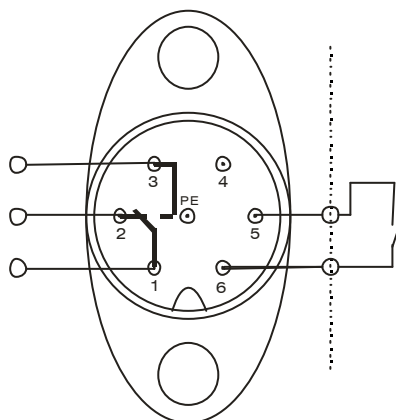

5 Application



WARNING!

The charging units connected to the charging generator conduct high voltage during operation!

Any contact may lead to injury and consequential accidents.

The operator must provide protective equipment against direct contact when installing the charging units. Make sure that you read and observe the operating instructions of the connected charging units.

The unit may be put into operation by trained electricians only or by persons instructed in the potential dangers. The above mentioned persons must have read the operating instructions and must follow the instructions, notes and safety advice.

Preconditions:

The charging generator and the charging units must be connected correctly.

5.1 Putting into operation



ATTENTION!

The setting under item 6 should be completed within 10 s, as otherwise a protective relay will switch off the high voltage. The signaling lamp flashes to indicate this status.

Continue adjusting the setting according to item 6 after pressing the reset pushbutton.

- 1 Switch on unit at mains switch. The green control lamp lights up to control.
- 2 Turn high voltage potentiometer to the extreme left (minimum).
- 3 Turn current threshold potentiometer to the extreme right (maximum).
- 4 Put changeover switch for pulsed/continuous operation into required operation mode.
- 5 Set high voltage potentiometer to desired value. The voltage display (refer to page 8, Fig. 2, item 6) will indicate the adjusted voltage.
- 6 Once the process is running, turn the current threshold potentiometer towards the minimum until the signalling lamp lights up. Then turn it back slightly towards the maximum until the signalling lamp is extinguished. The current display (refer to page 8, Fig. 2, item 7) indicates the present current.

5.2

Instructions for setting the high voltage

The output voltage depends on the current load. This is why the voltage increases if an existing counter electrode is covered with insulating material.

If spark-over occurs, please set a lower voltage or increase the distance between the charging unit and the counter electrode or the opposing metal parts.

6 Remedy of defects



WARNING!

*High voltage!
Danger of fatal accidents!
Do not open unit!*

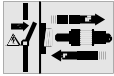

WARNING!

*Only plug in/unplug coaxial connector
when the unit is switched off!*

Any remedy of defects must be carried out by trained electricians only. The above mentioned person must have read the operating instructions and must follow the instructions, notes and safety advice.

In case of defects regarding the generator and the charging unit, please check for correct installation and fusing first (for replacement, refer to page 15, chapter 7.1).

6.1 Troubleshooting

Faults	Measures
No charging	Check mains voltage
	Check fuse (for replacement, refer to page 15, chapter 7.1)
	Check connection
	Clean charging unit
	Check charging unit for damages. If damaged, immediately shut down and secure against restarting.

If this does not remedy the defect, please return the charging generator and the charging unit to HAUG GmbH & Co. KG (see address on back page) for examination.

7

Maintenance and repairs**WARNING!**

*High voltage!
Danger of fatal accidents!
Do not open unit!*

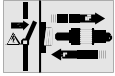
**WARNING!**

*Only plug in/unplug coaxial connector
when the unit is switched off!*

This unit does not include any parts which can be maintained or repaired by the operator. HAUG GmbH & Co. KG only is authorized to repair or calibrate the unit.

Should the unit prove defective or if a defect is suspected, switch off unit immediately and secure against subsequent reuse.

7.1

Replacing fuse

1. Switch off unit.
2. Determine and remove the cause for the blown fuse.
3. Detach the fuse holder using a screwdriver and lift out.
4. Replace fuse and reattach fuse holder.

Use the following fuses only:

Unit type	Fuse
AG 30 positive/negative 115 V	2,50 A slow, 5 x 20 mm
AG 30 positive/negative 230 V	1,25 A slow, 5 x 20 mm

The unit type and the rated voltage are indicated on the nameplate.
Only use fuses of the type indicated.

7.2 Accessories

Article	Order number
Circular plug	X – 0616
Right-angle plug	X – 5718
Signalling line K1 (incl. plug, assembled) 5 m shielded	06.8941.000
Signalling line K1 (incl. plug, assembled) 10 m shielded	06.8941.001
Signalling line K1 (incl. plug, assembled) 20 m shielded	06.8941.002

8 Technical data

8.1 Connectable charging units

Charging bars	ALS, AS SL
Charging electrodes	AE, AE SL, SA, PAE

8.2 Characteristics and specification

Reference temperature 23 °C

High-voltage terminals	2 HAUG High-voltage terminals (standard)
High voltage	Approx. 40 kVDC (no load), positive or negative
Short-circuit current	$I_k \leq 4,5 \text{ mA}$
Connection socket K1	Contact load 24 VAC / 35 VDC, max. 50 mA
Max. cycle frequency	1 Hz

8.3 Supply voltage



ATTENTION!

Always connect the PE conductor (green/yellow conductor) to the protective earth of the mains!

Unit type	Nominal value	Operating range	Frequency range	Power input
AG 30 pos./neg.	115 VAC	$\pm 10 \%$	50 - 60 Hz	$P_{\max} = 60 \text{ VA}$
AG 30 pos./neg.	230 VAC	$\pm 10 \%$	50 - 60 Hz	$P_{\max} = 60 \text{ VA}$

8.4 Ambient conditions

Ambient temperature:	
Rated application range	+5 °C to +45 °C
Extreme range for storage and transport	-15 °C to +60 °C
Humidity:	
Rated application range	20 % to 65 % RF
Extreme range for storage and transport	0 % to 85 % RF
Air pressure:	
Rated application range	800 mbar to 1060 mbar
Vibrations:	
Extreme range for storage and transport	max. 1.5 g (10 to 55 Hz), 1 h
Shock	max. 15 g in each direction
Recommended service position:	vertical, supply cable downwards

8.5 Housing

Protection type	IP 54
Protection class	I
Mains supply	approx. 2,6 m fixed on unit
Dimensions:	
Height	approx. 345 mm
Width	approx. 370 mm
Depth	approx. 162 mm
Weight:	approx. 13 kg

9**Disposal**

Observe and maintain national and regional waste disposal regulations for the disposal of the unit!

made by



HAUG GmbH & Co.KG

Friedrich-List-Straße 18
D-70771 Leinfelden-Echterdingen
Telefon 07 11 / 94 98 - 0
Telefax 07 11 / 94 98 - 298

www.haug.de
E-Mail: info@haug.de

HAUG Biel AG

Postfach
CH-2500 Biel/ Bienne 6
Johann-Renfer-Strasse 60
CH-2500 Biel/ Bienne 6
Telefon 0 32 / 3 44 96 96
Telefax 0 32 / 3 44 96 97

www.haug.de
E-Mail: info@haug-biel.ch