

Ionizing bars

Keep for future use!



Models (series):

EI RN, EI RNE, EI RN OF, EI RA, EI RAE, EI RA OF
EI RD, EI RDE, EI RDA, EI RDAE
EI VS, EI VSE, EI VS OF, EI VSA, EI VSAE, EI VSA OF
EI VD, EI VDE, EI VDA, EI VDAE
EI HRN, EI HRA, EI HRE, EI HRAE
EI VC, EI VCA, EI VCE, EI VCAE
EI PRX, EI PRV
EI PS
EI SL

Static Line





Table of contents

1	Operator instructions	4
2	Safety.....	5
3	Intended use	7
4	Description of unit	8
5	Installation	12
6	Maintenance	16
7	Troubleshooting	18
8	Accessories	19
9	Technical data	24
9.1	Supply voltage	24
9.2	Ambient conditions	24
9.3	Dimensions	25
10	Decommissioning	26
11	Disposal	27

1 Operator instructions

NOTE: *Important notes and additional information.*

Make sure you read these Operating Instructions completely before installing and using the unit for the first time. They form a part of the unit and must be retained for later use or subsequent owners.

Safety instructions must be observed and followed at all times.

The unit is operationally safe, provided that it is operated in accordance with its intended use.

The following signal words are used:



WARNING

If ignored,

- severe personal injury
- or death may result



CAUTION

If ignored,

- light personal injury may result

ATTENTION

If ignored,

- light property damage with damage to the unit may result

2 Safety

All activities must be performed only by persons authorized by the operator. These persons must have basic knowhow in the fields of electrical and mechanical engineering and must have read and understood the operating instructions.

Switch off the power supply before commencing work on the unit, and secure against inadvertent switching on.

The unit does not include any parts which can be repaired by the operator. For reasons of safety, unauthorized conversions and modifications of the unit are not permitted.

Any damage to the unit may result in the risk of electric shocks. In the event of any visible damage or suspected electrical defects, take the unit out of operation immediately and secure against reuse.

WARNING!

The unit may impair the function of heart pacemakers.

The high electric voltage in the unit generates an alternating field with 50 Hz which may influence the function of the pacemaker. Malfunction of a heart pacemaker may result in ventricular fibrillation or cardiac arrest.

- Persons with heart pacemakers must keep a distance of more than 50 cm from the unit.
- The operator must identify the danger zone around the unit with a warning sign.
- The accident prevention regulations according to BGV A8 must be observed.
- An expert study on the influence of ionization systems on implanted heart pacemakers is available from HAUG GmbH & Co. KG.

CAUTION!

The ionizing pins pose an injury risk. When touched, the ionizing pins may lead to stab or tear injuries to the hands.

- Protective gloves must be worn when working on the unit (EN 388 3122).

During operation of the units, small quantities of ozone will form. A very high ozone concentration and prolonged continuous exposure times may result in headache, irritation to the eyes, circulatory problems etc.

- In order to ensure adherence to maximum permitted ozone concentrations at the workplace, make sure that the workplace is ventilated sufficiently during operation of the units.
- An expert study on ozone emissions of ionization systems is available from HAUG GmbH & Co. KG.

ATTENTION!

Wetness and moisture may result in spark-overs and leakage paths. Damage to the unit and short circuits are the likely consequence.

- The units must be protected from humidity and moisture.
- Never use high-pressure cleaners to clean the units.

When the power pack is switched on, contact or separation spark-overs may occur when the high-voltage plug is plugged in or unplugged. This may result in damage to the power pack or defects.

- Only plug in/unplug the high-voltage plug when the power pack is switched off.

Any torsion or bending of the unit may result in hairline cracks in the interior. This will allow leakage paths for the high voltage to be formed which will damage the unit.

- Do not twist or bend the unit.

By pulling the high-voltage cable, gaps at the contact points in the high-voltage plug and unit connector may form.

Arcing may occur at the gaps due to the high voltage, resulting in damage to the unit.

- Do not pull the high-voltage cable.

3 Intended use

The unit is intended for the elimination of electrostatic charges from paper, films and foils, textiles, glass, plastics etc.

The units of the VC series (EI VC, EI VCA, EI VCE, EI VCAE) are designed specifically for manufacturing industries such as pharmaceuticals, cosmetics and food.

NOTE: *The VC series units must be cleaned with different cleaning agents. For instructions on the cleaning of the "VC series", refer to Section "Cleaning".*

This unit is only approved for alternating high voltage. The high-voltage plug (System X-2000) is designed for all HAUG power packs. The unit must only be connected to power packs made by HAUG. The warranty only covers units and accessories of HAUG GmbH & Co. KG.

The installation and operating conditions indicated in these Operating Instructions must be adhered to.



WARNING

Risk of explosion!
Ignitable sparks may form at the units.

- Do not install or use the units in areas subject to explosion hazards.

4 Description of unit

High-voltage plug System X-2000

The high-voltage plug system can be taken apart. This allows the high-voltage plug to be assembled or dismantled.



Round ionizing bars:

EI RN, EI RNE, EI RA, EI RAE, EI VS,
EI VSE, EI VSA, EI VSAE, EI HRN,
EI HRA, EI HRE, EI HRAE, EI VC, EI VCA,
EI VCE, EI VCAE, EI SL

- A: Pin bushing
- B: Screw cap
- C: High-voltage cable
- D: Starter piece
- E: Ionizing pin
- F: Counter-electrode
- G: End piece

X: High-voltage plug (X-2000)

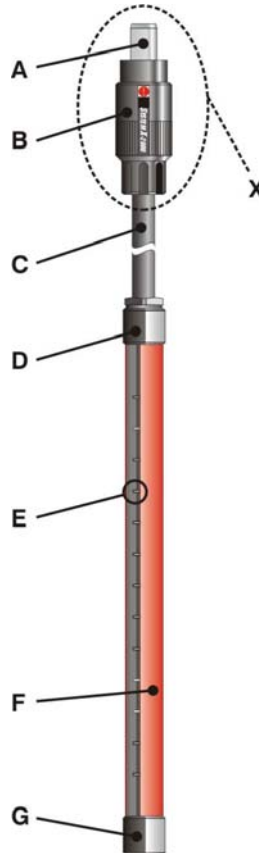

Round ionizing bars with visual function indicator:

EI RN OF, EI RA OF, EI VS OF,
EI VSA OF

- A: Pin bushing
- B: Screw cap
- C: High-voltage cable
- D: Starter piece
- E: Ionizing pin
- F: Counter-electrode
- G: End piece
- H: Visual function indicator

X: High-voltage plug (X-2000)

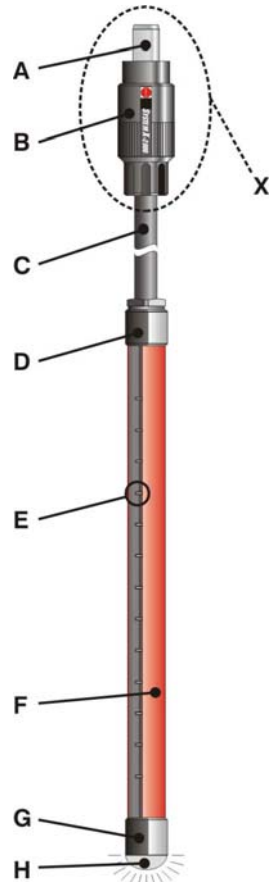

NOTE: *The visual function indicator at the end of the unit flashes during operation. The flashing indicates that the unit is working properly. If the visual function indicator does not flash during operation, a failure has occurred. Refer to Section "Troubleshooting".*

Tandem ionizing bars:

EI RD, EI RDE, EI RDA, EI RDAE, EI VD,
EI VDE, EI VDA, EI VDAE

These correspond to the round ionizing bars. Double design with tandem bar holder.



Rectangular ionizing bars:

EI PS

- A: Pin bushing
- B: Screw cap
- C: High-voltage cable
- D: Connection cover
- E: Ionizing pin
- F: Counter-electrode
- G: Fixing screws M4

- Adjustable over the complete bar length

H: End cover:

- Can be removed for replacing fixing screws

X: High-voltage plug (X-2000)

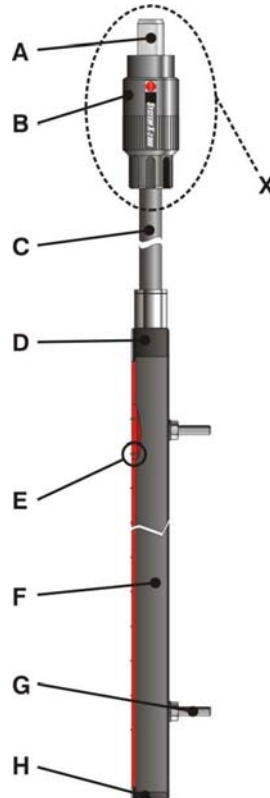

Rectangular ionizing bars:

EI PRX, EI PRV

A: Pin bushing

B: Screw cap

C: High-voltage cable

D: Connection sleeve

E: Ionizing pin

F: Counter-electrode

G: Fixing screws M4

- From a bar length of 500 mm, an additional fixing screw is provided in the centre

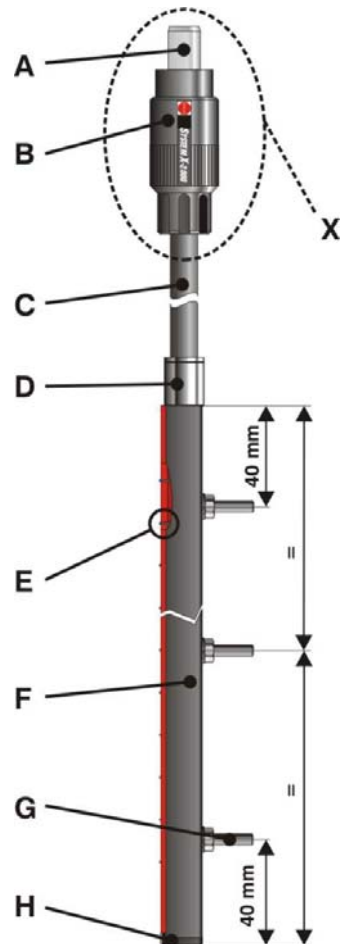

H: End cover

X: High-voltage plug (X-2000)

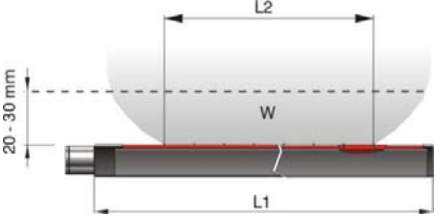
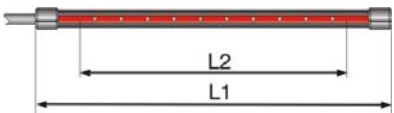

5 Installation

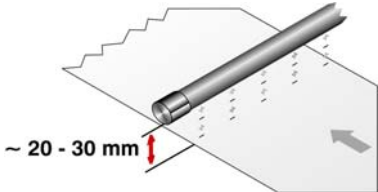
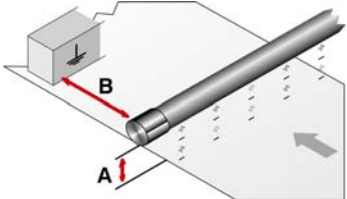
<p>1. Check whether the unit corresponds to the ordering data. In the event of any damage to the unit, contact HAUG GmbH & Co. KG.</p>	
<p>2. During installation, please remember that the units have a restricted effective range (W). The effective range (W) extends in a way similar to the one shown in the illustration.</p> <ul style="list-style-type: none"> • The length (L2) of the effective range can be calculated as follows. 	
<p>The length of the unit (L1), minus the following lengths, is the length of the effective range (L2).</p> <p>EI RN, EI RNE, EI RA, EI RAE $L2 = L1 - 100 \text{ mm}$</p> <p>EI RN OF, EI RA OF $L2 = L1 - 130 \text{ mm}$</p> <p>EI VS, EI VSE, EI VSA, EI VSAE $L2 = L1 - 120 \text{ mm}$</p> <p>EI VS OF, EI VSA OF $L2 = L1 - 150 \text{ mm}$</p> <p>EI RD, EI RDE, EI RDA, EI RDAE $L2 = L1 - 100 \text{ mm}$</p> <p>EI VD, EI VDE, EI VDA, EI VDAE $L2 = L1 - 120 \text{ mm}$</p> <p>EI HRN, EI HRA, EI HRE, EI HRAE $L2 = L1 - 100 \text{ mm}$</p> <p>EI VC, EI VCA, EI VCE, EI VCAE $L2 = L1 - 120 \text{ mm}$</p> <p>EI PRX, EI PRV $L2 = L1 - 40 \text{ mm}$</p> <p>EI PS $L2 = L1 - 20 \text{ mm}$</p> <p>EI SL $L2 = L1 - 140 \text{ mm}$</p>	

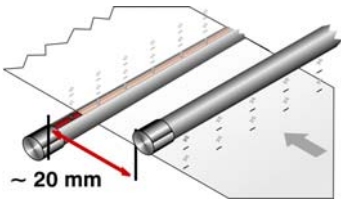
<p>3. Prepare the installation site with regard to the following installation parameters:</p>	
<p>The most favourable distance of the unit to the material to be ionized is approx. 20 – 30 mm. The limit values for the ionizing effect are at 10 mm min. and 80 mm max.</p>	
<p>The distance of the unit to an earthed machine part (B) must be greater than the distance to the material to be ionized (A).</p>	
<p>No earthed machine parts must lie behind the material to be ionized.</p>	
<p>If two units are used</p> <ul style="list-style-type: none"> ● one unit each must be installed above and below the material to be ionized. ● the units must not face each other. ● the units must be offset by approx. 20 mm. 	

5 Installation

If two units are used with high conveying speeds,

- the units must be installed next to each other.
- a distance of approx. 20 mm must be maintained.

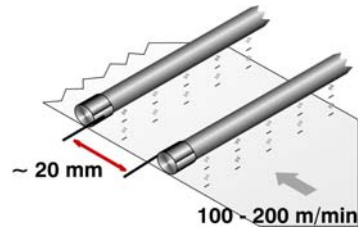

4. Fix the unit within the machine.

ATTENTION

No ionization is possible at locations where the ionizing pins are covered by fixing elements or machine parts. At the covered locations, an arc damaging the unit will form as result of dirt or an electrically conductive material.

- Never fix mounting elements over the ionizing pins.



Round ionizing bars:

Attach the unit in the machine with the starting and end piece mounted in holders. Longer units may sag in the centre; a holder can therefore be attached at the counter-electrode for additional support.



Rectangular ionizing bars:

The unit is fixed using the screws.



Note: Suitable mounting material and bar holders are available as accessories from HAUG GmbH & Co. KG. Refer to Section Accessories.

ATTENTION

Any kinking and bending of the high-voltage cable may damage the shielding and insulation of the cable resulting in short circuits.

- The high-voltage cable must not be kinked.
- When routing around bends, the bending radius must not be smaller than 50 mm.



5. Switch off power pack and secure against inadvertent operation.
6. Plug the high-voltage plug of the unit into the high-voltage socket of the power pack and push at the high-voltage cable until the stop is reached.
7. Screw the screw cap onto the high-voltage socket and tighten by hand.

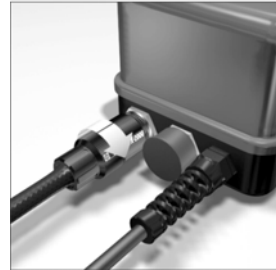

NOTE: *The use of the HAUG tape roller allows the unit to be masked with adhesive tape such that the ionizing pins remain free. This protects the unit from heavy contamination.*

The HAUG tape roller can only be used for the round design.

6 Maintenance

Clean the units at intervals of at least 14 days. The cleaning interval should be shortened when working in a heavily contaminated environment. When a deterioration of the cleaning effect is noticed, cleaning can improve ionization.

Cleaning of the VC Series

ATTENTION

The unit may be damaged if inappropriate brushes or cleaning agents are used.

- Only use soft-grade synthetic fibre brushes.
- Only use pharmaceutical alcohol.

Dry cleaning

1. Switch off power pack and secure against inadvertent operation.
2. Disconnect the unit from the power pack.
3. Brush the ionizing pins using a synthetic fibre brush.
4. Vacuum out the unit.
5. Check the high-voltage connections and high-voltage plugs for contamination. The connections must be clean and dry.
6. Reconnect the unit to the power pack.

NOTE: *If dry cleaning does not yield the desired result, continue by using a wet cleaning process.*

Moist cleaning

1. Switch off power pack and secure against inadvertent operation.
2. Disconnect the unit from the power pack.
3. Wet the synthetic fibre brush with a pharmaceutical alcohol.
4. Brush the ionizing pins of the unit.
5. Blow off the unit with clean compressed air (max. 6 bar) and allow to dry.
6. Check the high-voltage connections and high-voltage plugs for contamination. The connections must be clean and dry.
7. Reconnect the unit to the power pack.

NOTE: *Disinfect cleaning accessories for clean production areas following cleaning.*

Cleaning of all series except VC Series

ATTENTION

The unit may be damaged if inappropriate brushes or cleaning agents are used.

- We strongly recommend the exclusive use of **cleaning accessories** from HAUG GmbH & Co. KG. Refer to Section Accessories.

Dry cleaning

1. Switch off power pack and secure against inadvertent operation.
2. Disconnect the unit from the power pack.
3. Brush the ionizing pins of the unit using special cleaning brush **RB1**.
4. Blow off the unit with clean compressed air (max. 6 bar).
5. Check the high-voltage connections and high-voltage plugs for contamination. The connections must be clean and dry.
6. Reconnect the unit to the power pack.

NOTE: *If dry cleaning does not yield the desired result, continue by using a wet cleaning process.*

Moist cleaning









1. Switch off power pack and secure against inadvertent operation.
2. Disconnect the unit from the power pack.
3. Wet the special cleaning brush **RB1** with the special cleaning agent **SRM1**. The special cleaning system **RS2** may also be used for cleaning.
4. Brush the ionizing pins of the unit.
5. Blow off the unit with clean compressed air (max. 6 bar) and allow to dry.
6. Check the high-voltage connections and high-voltage plugs for contamination. The connections must be clean and dry.
7. Reconnect the unit to the power pack.

7 Troubleshooting

Error	Cause	Measure for elimination
No ionization	Unit is dirty	Clean unit
	No high voltage	Check power pack
		Check connections
Error within unit	Check unit using the Combicheck. See Section Accessories	
Visual function indicator not flashing. Only for EI RN OF, EI RA OF, EI VS OF, EI VSA OF	Error in ionization system	Check power pack
		Check connections
		Check unit using the Combicheck. See Section Accessories
Sparks-over	The unit is covered with an electrically conductive deposit	Clean unit
	The ionizing pins are too close to an electrically conductive material	Increase distance to the cause
	The unit is damaged	Switch off unit automatically and secure against switching on

NOTE: *If the error cannot be removed in this way, return the unit and power pack for checking to HAUG GmbH & Co. KG (for address, see reverse).*

8 Accessories

Article	Illustrations	Order number
HAUG power pack		On request
Special cleaning fluid SRM1		10.7220.000
Special cleaning brush RB1		10.7218.000
Special cleaning system RS2		10.7218.004
Circular brush for special cleaning system		X - 5677
HAUG Tape-Roller		10.0008.000
Adhesive tape "crepe"		X - 0167
Polyester insulating tape		X - 7793
Combicheck		12.7231.000

Article	Illustrations	Order number
Bracket, small Continuous groove		X - 0423
Bracket, large		X - 0404
"Klick-Zack" special holder		10.0004.000

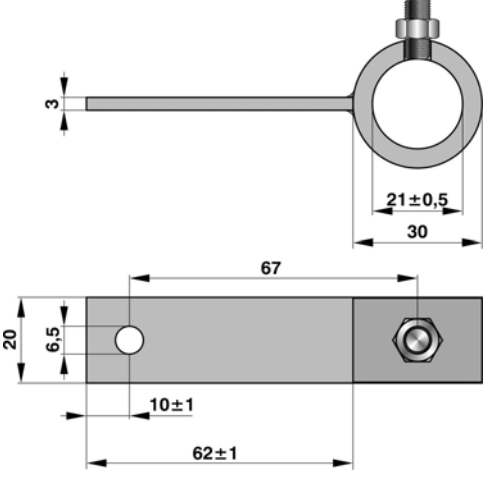
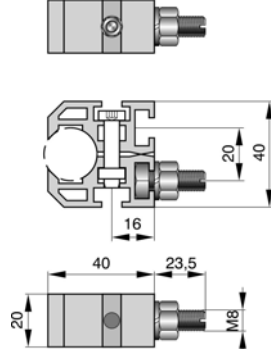
Article	Illustrations	Order number
Holder, closed		10.0227.000
Clamping holder, clamping range 18-20 mm		10.0268.000

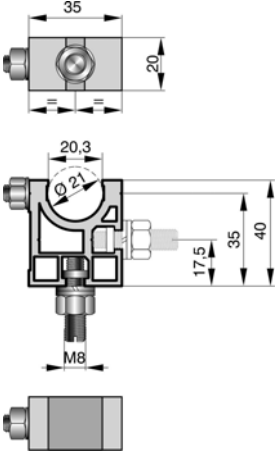
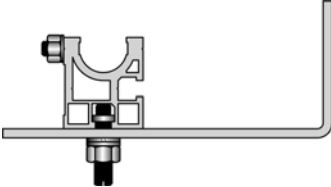
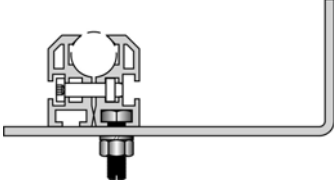
Article	Illustrations	Order number
Block, half open		10.0301.000
Set: Block, half open, with large angle		10.0203.000
Set: Clamping holder with large angle		10.0266.000

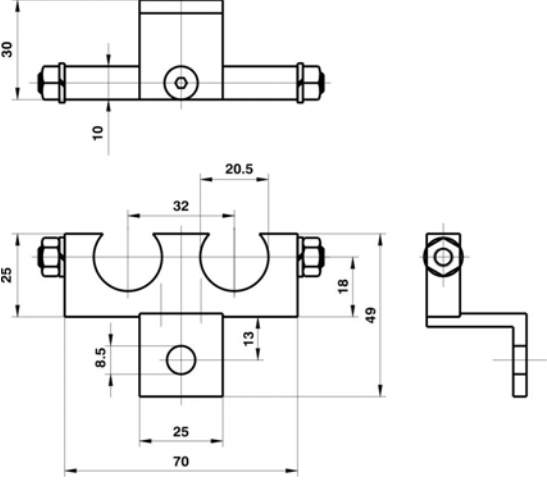
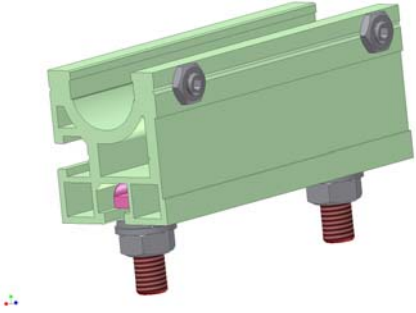
Article	Illustrations	Order number
<p>Holder for tandem ionizing bars</p>		<p>10.0379.000</p>
<p>Cross bar: - Length depends on ionizing bar - Fixing screws movable (M8)</p>		<p>06.0100.030</p>

9 Technical data

9.1 Supply voltage

Electric connection to HAUG power pack	7 – 8 kVAC
--	------------

9.2 Ambient conditions

Use in areas with potentially explosive atmospheres is prohibited	
Only for inside use	
Temperature:	
Rated application range	+5 °C to +45 °C
Rated application range EI HRN, EI HRA, EI HRE, EI HRAE	+5 °C bis +130 °C
Extreme range for storage and transport	-15 °C to +60 °C
Humidity:	
Rated application range	20 % to 65 % RF
Extreme range for storage and transport	0 % to 85 % RF

9.3 Dimensions

Type	Cross-section	Length
EI RN, EI RNE, EI RN OF, EI RA, EI RAE, EI RA OF	Ø 20 mm	150 - 2500 mm
EI VS, EI VSE, EI VS OF, EI VSA, EI VSAE, EI VSA OF	Ø 20 mm	150 - 2500 mm
EI RD, EI RDE, EI RDA, EI RDAE	Ø 20 mm	150 - 2500 mm
EI VD, EI VDE, EI VDA, EI VDAE	Ø 20 mm	150 - 2500 mm
EI HRN, EI HRA, EI HRE, EI HRAE	Ø 20 mm	150 - 2500 mm
EI VC, EI VCE, EI VCA, EI VCAE	Ø 20 mm	150 - 2500 mm
EI PRX	14 x 14 mm	60 - 1500 mm
EI PRV	14 x 16 mm	60 - 1500 mm
EI PS	14 x 16.5 mm	60 - 1500 mm
EI SL	Ø 25 mm	150 - 2500 mm
High-voltage cable	-	Customized

10 Decommissioning

1. Switch off the machine and secure against unintended switching on.
2. Switch off power pack and secure against inadvertent operation.
3. Disconnect the unit from the power pack.
4. Dismantle the unit from the machine.

11 Disposal

Observe and maintain national and regional waste disposal regulations for the disposal of the unit.

made by



HAUG GmbH & Co. KG

Friedrich-List-Straße 18
D-70771 Leinfelden-Echterdingen
Telefon 07 11 / 94 98 - 0
Telefax 07 11 / 94 98 - 298

www.haug.de
E-Mail: info@haug.de

HAUG Biel AG

Postfach
CH-2500 Biel/Bienne 6
Johann-Renfer-Strasse 60
CH-2500 Biel/Bienne 6
Telefon 0 32 / 3 44 96 96
Telefax 0 32 / 3 44 96 97

www.haug.de
E-Mail: info@haug-biel.ch